

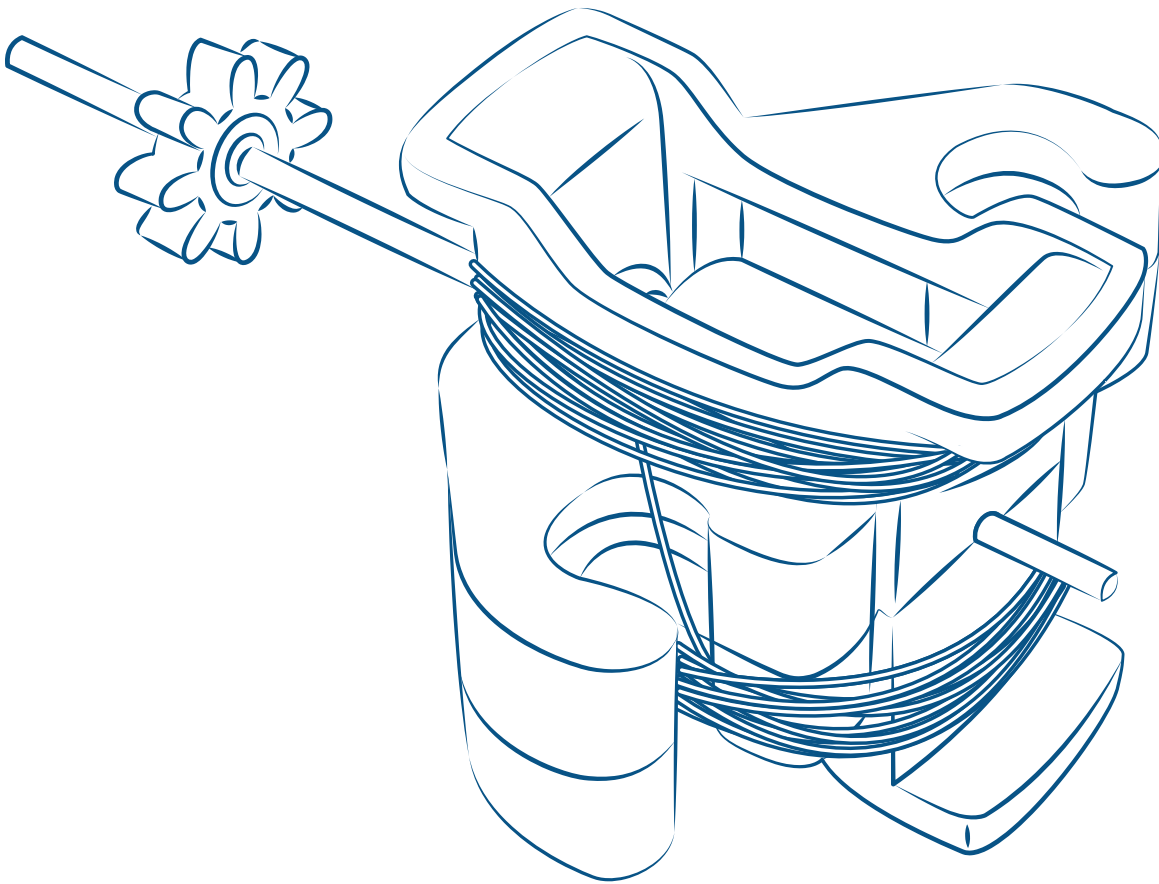

Advanced Wind Experiment Kit GENPack Module



instructions

About KidWind

The KidWind Project is a team of teachers, students, engineers, and practitioners exploring the science behind wind energy in classrooms around the US. Our goal is to introduce as many people as possible to the elegance of renewable energy through hands-on science activities which are challenging, engaging, and teach basic science principles.

While improving science education is our main goal, we also aim to help schools become important resources for both students and the general public, to learn about and see renewable energy in action.

Thanks to ...

We would like to thank the Wright Center for Science Education at Tufts University for giving us the time and space to develop this idea into a useful project for thousands of teachers.

We would also like to thank Trudy Forsyth at the National Wind Technology Center and Richard Michaud at the Boston Office of the Department of Energy for having the vision and foresight to help establish the KidWind Project in 2004. Lastly, we would like to thank all the teachers for their keen insight and feedback on making our kits and materials first rate!

Wind for All

At KidWind, we strongly believe that K–12 education is an important foundation for promoting a more robust understanding of the opportunities and challenges that emerging clean energy technologies present.

The Wind for All program seeks to support teachers and students all over the globe who do not have the financial capacity to access our training programs and equipment. We believe that all teachers and students—regardless of where they live or what school they attend—must be part of the clean energy future.

A Note on Reproduction

This work may not be reproduced by mechanical or electronic means without written permission from KidWind, except for educational uses by teachers in a classroom situation or a teacher training workshop. For permission to copy portions or all of this material for other purposes, such as for inclusion in other documents, please contact Michael Arquin at KidWind: michael@KidWind.org

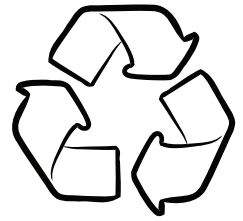

Our plastic components are made from recycled resins.



Made in US

We source domestically whenever possible, and assemble and pack our kits in St. Paul, MN.



Proceeds from your purchase help us train and supply teachers.

Parts

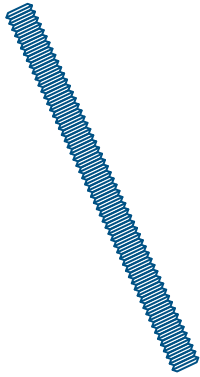

Nylon threaded rod (2)



Wing nuts (2)

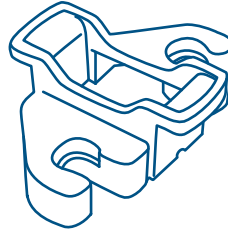

Coil housing (2)

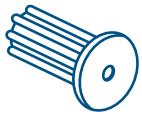

Magnet bushings (2)



Neodymium magnet (1)



Nuts (1)

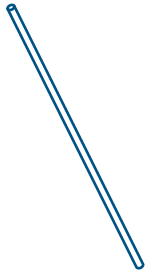

Steel shaft (2)

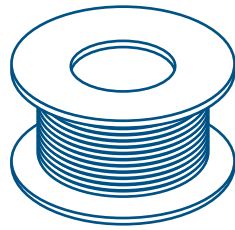

Magnet wire (1)



Rectifier (1)

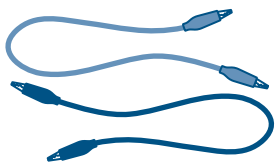

Alligator clip cords (2)

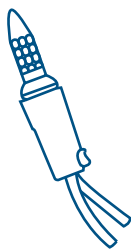

LED (2)



Red-green LED (2)



8-tooth gear (1)



1" tubing (1)



Rubber bands (2)

Advanced Wind Experiment Kit GENPack Module

Parts List

- 2 1/4-20 Nylon Threaded Rod
- 2 1/4-20 Wing Nuts
- 2 Coil Housings
- 2 Magnet Bushings
- 1 Neodymium Magnet (.75"x.75")
- 6 1/4-20 Nuts
- 1 Steel Shaft (5/64" x 3.75")
- 1 Spool of 28 gauge magnet wire
- 1 Rectifier
- 1 Alligator Clip Cord Pair
- 2 LED (Red or Green)
- 2 BiColor LED (Red/Green)
- 1 8 Tooth Gear
- 1 Pieces of 6" tubing
- 2 Rubber bands

You will need these tools:

- Wire Cutters, Scissors or Xacto Knife
- Electrical or Duct Tape

NOTE: The GENPack is an accessory to the Kid-Wind Advanced Wind Experiment Kit. If you do not have this kit it will be very challenging, but not impossible, to make this device work.

With the Advanced Wind Experiment Kit and GENPack module you can vary blades, gears, types of generators. This device can do it all!

Make sure you have put your turbine together and are ready to proceed. You will need to make some minor modifications to your Advanced Wind Experiment Kit to use the GENPack module.

FOR MORE HELP

A video of how to assemble your GENPack is available at the KidWind Website: www.KidWind.org/videos

⚠ CAUTION: STRONG MAGNETS

Magnets in this kit should never be placed near people with pacemakers or other medical electronics. Proper operation of pacemakers and other medical devices may be jeopardized by being in close proximity with the strong magnetic field created by this product.

*If you mess with **two** neodymium supermagnets, you are bound to pinch your fingers if you let them come together. This really hurts! Also, you should wear safety glasses, since when two magnets slam together, they may launch tiny chips at high velocities. We have had 3/4" magnets accidentally fall together and be completely shattered. The things are brittle! Magnets larger than 1/4" are **not for unsupervised children**.*

It is advised to work on a non metallic surface and keep all tools and metal objects at least two feet away when you are constructing your generator.

Computers, compasses and onboard electronics may be adversely affected if placed in close proximity with this product. Store this product at least 3 feet from these devices.



Axially magnetized



Diametrically magnetized

Setting up the GENPack

Step 1: Tools & Your Advanced Wind Experiment Kit

Before you start you will need your assembled Advanced Wind Experiment Kit and some basic tools listed in the materials section.

Step 2: Mounting the Magnet to the driveshaft

Push a magnet bushing on each end of the magnet and push them tight together. You may need to tap them in with a hammer to make them tight.

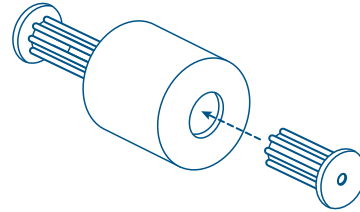

Mount small gear onto one end of driveshaft. The gear has a very tight fit on the driveshaft. Use a hammer to get it started.

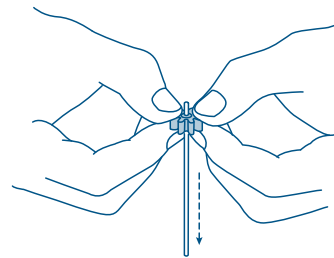

Mount the magnet with bushings onto the shaft.

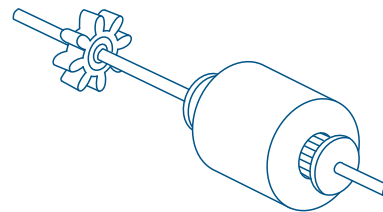

The end without the gear should only stick out about 1/2 an inch, so that it fits into the nacelle.

The magnet bushing can slip on the shaft at high rates of spin or high torque moments. To reduce this from happening can glue the bushings to the shaft as you press them on—a dab of Gorilla glue will do it.

You have completed the magnet drivetrain!

✳ *Experimental Note:* Your kit comes with a neodymium magnet that is .75" long x .75" wide . You could try to use magnets of other sizes and strengths.

It is important to note that this ring magnet has diametrical magnetization, this is different than most ring magnets. When looking for other magnets for this kit make sure that the poles are *diametrically magnetized*.

Step 3: Installing Magnet Drivetrain into GENPack Housing

Place the magnet drivetrain into the grooves of one coil housing. Note which direction the gear end of the shaft faces. This will need to be facing out when you install into the Advanced Wind Experiment Kit.

Place other coil housing piece on top of the plastic base piece.

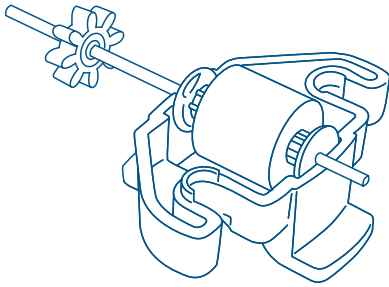

Secure the two plastic pieces together using masking tape, duct tape or rubber bands.

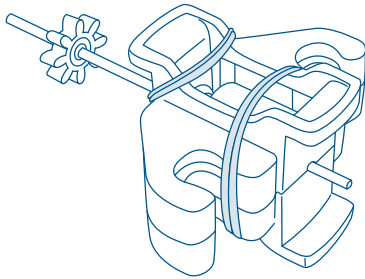

This will hold the module together while you wind the coils.

Step 4: Winding the GENPack Coils

As you start to wind the coils leave about 2-3 feet of the wire hanging free, and start winding on the bottom plastic piece.

Make sure that the wire does not cover the bolt channels.

Wind about 150 turns onto the bottom. Continue winding about 150 turns onto the top piece. These coils should be connected. They should be in the same direction.

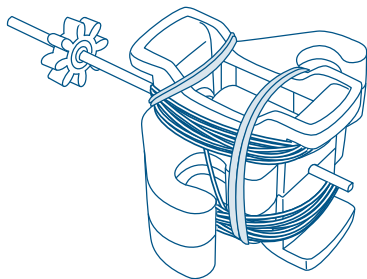

Use a small piece of tape to secure the last winding in place. Cut the wire to leave about two feet of wire at the end.

Using sandpaper, or sharp knife, scrape the insulation off the ends of the wire. You will want about one inch of un-insulated wire on each end so you can connect wire leads with alligator clamps.

NEODYMIUM MAGNET

Neodymium magnets are the strongest permanent magnets known (also known as NdFeB, NIB, or Neo magnet). A type of rare-earth magnet, a permanent magnet made from an alloy of neodymium, iron, and boron to form the $Nd_2Fe_{14}B$ tetragonal crystalline structure.

Neodymium magnets appear in products such as microphones, professional loudspeakers, in-ear headphones, guitar and bass guitar pick-ups and computer hard disks where low mass, small volume, or strong magnetic fields are required. Because of its high magnetic-flux, it is often used in the electric motors of hybrid automobiles and in the electricity generators of commercial wind turbine generators.

WINDING COILS

It is important that your coils are wound in the same direction or else when you run the GENPack the output from one coil can cancel the other coil out. We have helpful videos on this at www.KidWind.org/videos

TIPS ON WIRING THE GENERATOR

The best way is to wire with one continuous piece of wire. Start on the bottom, winding about 150 revolutions, lead the wire up to the top, and WINDING IN THE SAME DIRECTION (ie clockwise as viewed from above), wind about 150 revolutions on the top. Leave a length of about 6 to 10 inches of wire at each end.

Wire sizing

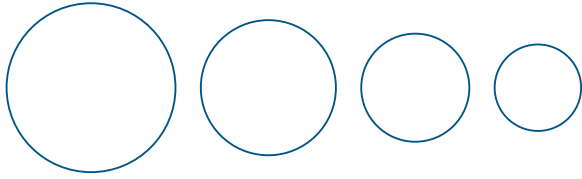

Smaller Gauge

Larger Gauge

Wire gauging is a bit counterintuitive. The larger the number gauge, the smaller the wire diameter.

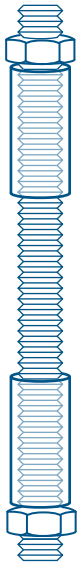

* *Experimental Note:* Your kit comes with 400 feet of 28 gauge magnet wire. Changing the numbers of turns on your coils and the size of your magnet wire can dramatically affect electrical output and torque requirement of the generator. We recommend 24 – 32 gauge wire.

150 turns of 28 gauge wire on the GENPack is about 60 feet of wire.

Step 5: Advanced Wind Experiment Kit Head Modifications

Replace two of the steel bolts on the Advanced Wind Experiment Kit with the nylon rods. The nylon rods are not magnetic, so they will not interfere with the neodymium magnet in your new generator.

You will also want to install two ½" pieces of tubing on each of the nylon rods before you install on the Advanced Wind Experiment Kit. These will help to hold the GENPack solidly while buffering the generator from vibrations of the moving turbine.

Step 6: Mounting the GENPack in the Advanced Wind Experiment Kit

Mount your GENPack module on the nylon rods so that the gear on the generator meshes with the larger gear of the turbine shaft.

Adjust the height so that the two gears mesh fully, but not so close that they bind.

Using your hand, spin the turbine blades to make sure the parts mesh smoothly.

* *Experimental Note:* The GENPack is little larger than a regular DC motor so you can only use the 64 tooth and 32 tooth gears with this generator.

You are now ready to do some wind energy experiments on the generator.

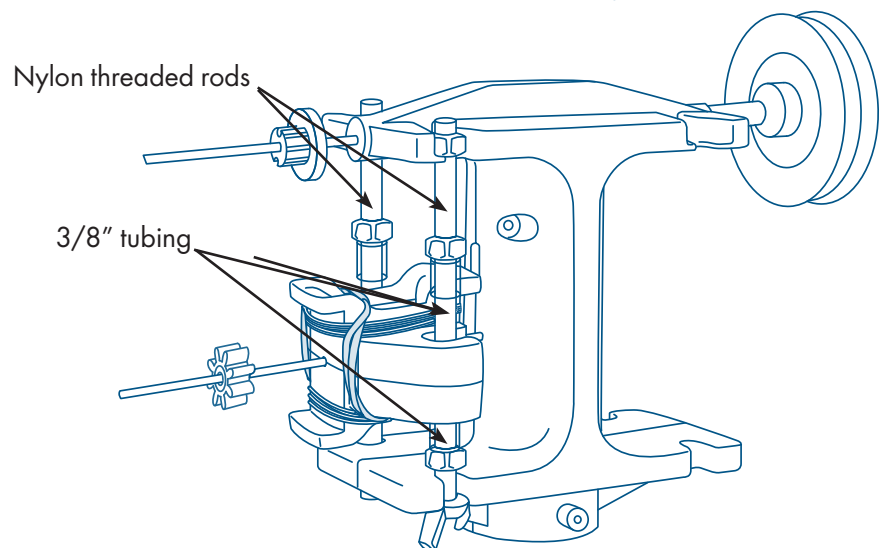

Simple Generator Theory

To help you experiment with your generator here is some very basic physics that relates to your generator. This can get much more complicated if you are so inclined.

Q: What is the expected output of a GENPack?

We have had the GENPack producing more than 8 volts and .5 amps. The output is highly dependent on how you wind your generator, how fast your fan can blow and how well you make your blades.

Q: What should happen if I change the number of windings on each coil?

A: The voltage is proportional to the number of windings multiplied by the size and the rate at which the magnetic field changes. So more windings gives higher voltage, and fewer windings gives lower voltage.

Here is a simple equation showing the relationship between number of coil windings, magnetic flux and speed of the spinning magnet in your GENPack.

$$\text{Voltage} = N \times \frac{\Delta(BA)}{\Delta(T)}$$

N = Number of Turns of Magnet Wire

B = Magnetic Field (teslas)

A = Area of Magnetic Field (m²)

T = Time (s)

Q: What should happen if I change the strength of the magnet?

A: Again, the voltage is proportional to the number of windings times the rate which the magnetic field changes. So (as long as the magnet is rotated at the same speed), a stronger magnet produces a stronger magnetic field change which means higher voltage.

Q: What happens when I change the size of the magnet wire?

A: If the number of windings remains the same, then changing the size of the wire does not change the voltage. (Except: If the wire size gets big enough that the coils get spaced farther away from the magnetic field, then the voltage goes down.) The main advantage of larger wire diameter is that there is less resistance in the wires if large currents flow, so the amperage and voltage will not drop as much by the resistance of the wire itself.

With smaller diameter magnet wire you can fit more turns in a smaller space closer to the magnetic flux. This could possibly increase your voltage. But the current moving through the smaller wires will meet more resistance and start to heat up the coil and reduce efficiency.

HOW TO INCREASE GENPACK OUTPUT

1. More turns of wire
2. Spin the magnet faster
3. Get a stronger magnet
4. Get a bigger magnet

What is happening inside of my GENPack?

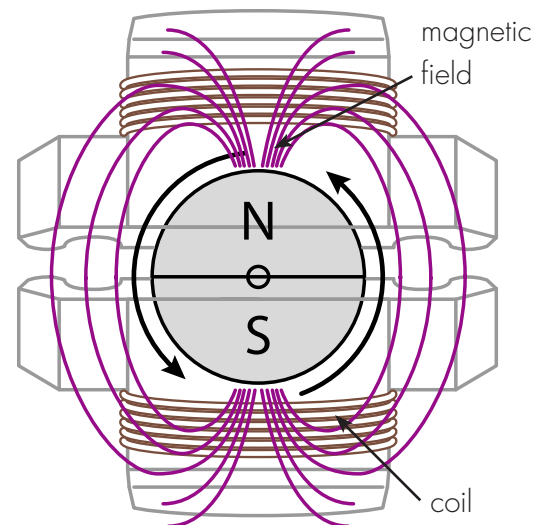

The GENPack produces voltage and current that is dependent on *magnetic field strength, the number of windings the coil has, how fast the magnet spins and the proximity of the coils to the magnetic field*. To increase your output you need to make the field spin faster, add more coils or get stronger magnets.

SOME SUPPORTING WEBSITES

www.animations.physics.unsw.edu.au/jw/electricmotors.html

www.en.wikipedia.org/wiki/Electrical_generator

www.en.wikipedia.org/wiki/Maxwell's_equations

www.allaboutcircuits.com/worksheets/acgen.html

www.micro.magnet.fsu.edu/electromag/electricity/generators/index.html

NOT GETTING ANY OUTPUT?

1. Check the direction of your coils.
2. Have you removed the enamel from the wires completely?
(See bottom of pg. 5)

GET DIRECT CURRENT FROM YOUR GENPACK

Using the provided rectifier will allow you to obtain direct current (DC) from the GENPack.

Wire the GENPack's two leads to the two center leads of the rectifier.

The output terminals from the rectifier are labeled "+" and "-", which may be connected to DC loads.

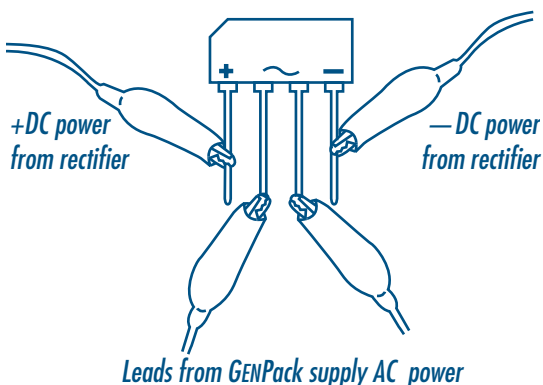

If you use the red LED, you will notice that it lights with one polarity of wiring, but not the other polarity (since LEDs only allow current to flow in one direction).

If you hook up the red/green LED, one color will light for each polarity of wiring.

Q: What should happen if I make the generator spin faster?

A: The electromotive force is proportional to the how fast the magnetic flux changes: So spinning the generator faster changes the magnetic flux faster, and provides a higher voltage.

Q: Why is there resistance to spinning when I have a load in the circuit?

A: Resistance in the circuit means the generator is powering something. If you get power out of the system, you must put power into the system.

The "power-in" multiplied by the "generator-efficiency" equals the "power-out." So: if you want to power a one-watt load, and the generator efficiency is 40% (0.4), then you must input 2.5 watts mechanical power.

Q: How is this AC generator different than the DC one that comes standard in the Advanced Wind Experiment Kit Kit.

A: The DC generator (also a DC motor) has the wire coils rotating inside the magnets. It also has brushes/split rings that turn what would have been AC into pulsed DC. For more info on this see the Electricity Section.

Q: What if I wind the top separately and the bottom separately?

A: If you connect the meter to only one of the coils (either one), you will get only about one-half the voltage that a full winding of top-and-bottom would yield.

You can still get full-voltage if you correctly connect the two coils together: Connect the wire-out of the bottom coil to the wire-in of the top coil. Now they act as one continuous coil, just as if you had wired them with one continuous piece of wire (as long as they were both wound the same direction: ie clockwise, as viewed from above).

If you incorrectly connect the two coils, they will oppose each other and your output will be approximately zero volts.

Q: What if I separately wind the bottom coil clockwise, and separately wind the top coil counter-clockwise (as viewed from above)?

A. Once again, a great science project if you have an oscilloscope. Or use a multimeter in a pinch. You can use either coil separately, and get about one-half the full voltage. Connect the wire-out of the bottom coil to the wire-out of the top coil (since it is wound in the opposite direction). Now they will act as a continuous piece of wire wound in the same direction, and deliver full voltage.

Using the Electrical Output of the GENPack

You will need to have some blades made for your turbine and then place your Advanced Wind Experiment Kit in front of a fan or other wind source for testing.

Unlike a DC motor that came in your Advanced Wind Experiment Kit this generator will produce Alternating Current.

If you wound the coils like we described you now have one continuous coil connected in series and wound in the same direction.

Connect a jumper wire to each end of both generator wires, and hook the wires to a multimeter. Set the multimeter to AC voltage for the first test.

If your meter shows you are getting some output then your system will be working fine. You can also just hand test your device to make sure you do not have any breaks in your wire.

If you can measure your power output now you can make changes to your turbine, generator and wind speed and collect data on how the output changes.

Conditioning and Using Your Power:

The power coming of your turbine can be a little ugly but we have included a simple item that can help you clean it up!

The rectifier we have included in the kit will convert the AC to DC.

Once you are generating in DC you can hook the GENPack to the water pump, power output board, fuel cells or other devices.

Remember to be careful using wind turbines with Fuel Cells as the membranes are very sensitive to high voltage and current inputs.

Collecting GENPack Data with an Oscilloscope

To get more insight into how your generator is working you can hook your GENPack module to a simple two-channel oscilloscope.

We have been using a simple USB oscilloscope from Parallax that works great to examine some output characteristics like frequency and voltage.

If you are planning to do some more in-depth experiments on your generator we highly recommend using a simple oscilloscope to visualize performance.

We have also been using Vernier logger software to get better data on output performance. If you head to the KidWind website we have downloadable Vernier files to help you collect this data. Head here for more details: <http://learn.kidwind.org/teach>

WHY DO THE LIGHTS FLICKER?

The GENPack produces alternating current (AC) as the magnet spins around near the coils. If you wire the output to the red LED you will get a pulsed light (since LEDs only accept one direction of current flow). If you can count fast (very fast), you may be able to count the LED light pulses and figure the frequency of the AC being generated.

Connect the red/green LED. The red will light with current flowing in one direction; the green will light with current flowing in the other direction.

Using your multimeter

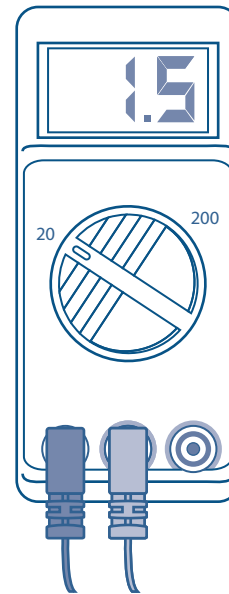

Measuring DC voltage

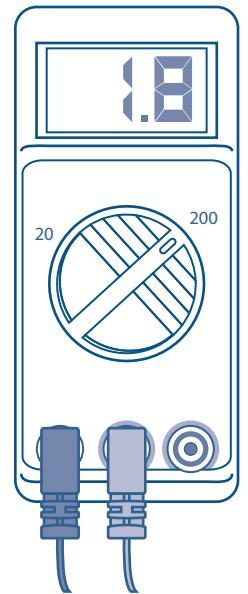

Measuring AC voltage

Electricity

Direct Current (DC)

DC is the flow of electric charge in only one direction. You may wish to think of water flowing constantly in a river, or water flowing in a pipe. It flows constantly in one direction. In an ideal world, DC flows at a constant rate. For instance a fully charged battery will provide a steady flow of electricity to a light bulb. But in the real world sometimes the rate of DC flow varies; engineers who design electronic circuits often put "filters" into the circuit to try to maintain the flow as steadily as possible. If the flow is not steady, then devices such as your computer or television would not work as they should.

DC is used in almost all electronic devices. How is this done since they are usually plugged into a wall outlet that provides AC? They have a part called the Power Supply, which converts household AC to the required DC.

Alternating Current (AC)

AC is very different from DC. With AC, the flow of electric charge moves forward, then backward, then forward, then backward, constantly.

Not only does AC change direction constantly, it also changes how strong it is. The current starts very slowly in one direction then builds up to a high value, slows down, and reverses direction. Then it does the same thing, building up to a maximum value, and then reversing again.

Since AC is constantly changing from high to low and back again constantly, the power that can be generated from AC is also changing constantly. The AC power that comes into your home (if you are in North America) changes direction and back again, 60 times each second. With some devices, such as a light bulb, you cannot visibly detect these cycles because they change very fast.

With electronic equipment, these changes in power are very apparent.

The number of cycles that occur in one second in AC is called the "frequency." The frequency is measured in cycles per second (CPS); also called Hertz (Hz).

In North America, our utilities provide us with 60 Hz AC. In some other parts of the world, for instance Europe, the standard is 50 Hz AC.

Since the power provided by AC is constantly changing, how do we know how much usable power is provided? Mathematically, we do a sort of averaging of the many changes, which gives us the "effective" power. This effective voltage number that we give to the AC means the AC provides the same amount of power as would DC at the same voltage. The technical term for this effective (usable) power of AC is the RMS

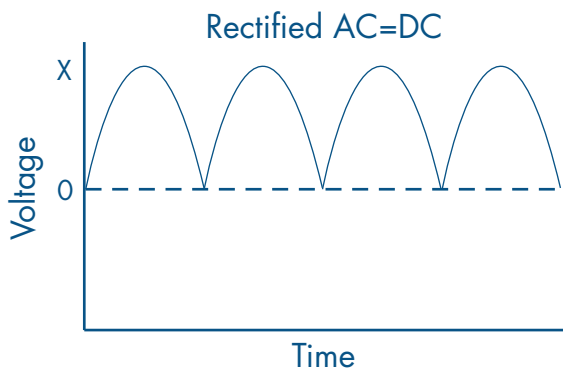
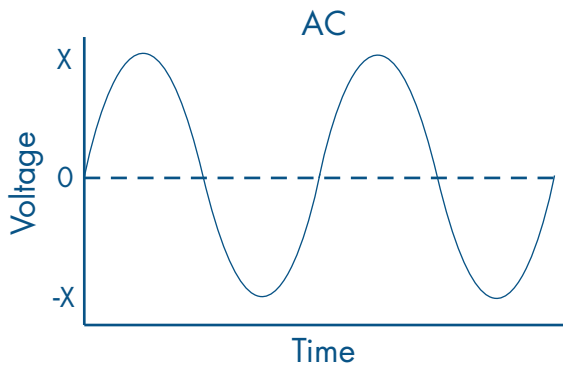
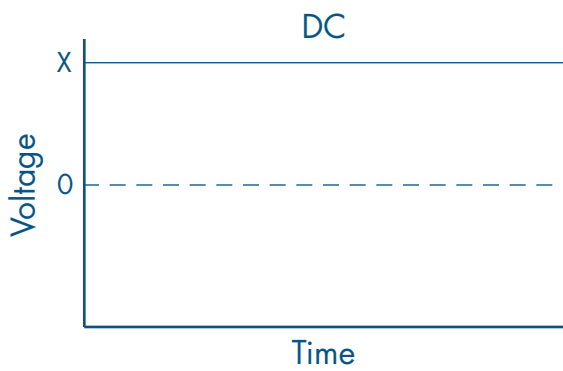

(root mean square) value of the voltage. The RMS value of an AC current is the number which represents the same power that a DC current at that voltage would produce.

In North America, most homes have 110 to 120 Volts AC electricity. (120 volts is the most commonly used term; 115 volts is the official National Electrical Code Standard.) This 120 VAC is the RMS value; so the AC electricity is equivalent in power to 120 VDC.

AC with an RMS of 120 volts actually goes from peaks of +170 volts to -170 volts. Students with a strong interest can search and find the formula to calculate RMS.

AC usually comes from large scale power generation by utility companies.

The advantage of AC is that it is easy to transform voltages: So it can be run efficiently at high voltage for long distances, and then a transformer can lower the voltage for residential or business use.

Direct Current may be obtained from Alternating Current by using a rectifier, a device that allows current to flow in only one direction.

Alternating Current may be obtained from Direct Current by using an inverter.

How a Generator Works

Electromagnetic Induction: It is the production of current across a conductor in a changing magnetic field. If a magnet moves near a wire, it induces electricity in the wire. If a wire moves near a magnet it will also induce electricity in the wire.

Electromagnetic induction is used in generators, electric motors, transformers, solenoids, etc.

The GENPack produces alternating current (AC) as the diametrically opposed magnet spins around next to the two coils. If you wire the output to the red LED you will get a pulsed light (since LEDs only accept one direction of current flow). If you can count fast (very fast), you may be able to count the LED light pulses and figure the frequency of the AC. (This pluses reflect how fast your magnet is spinning. Try lowering the fan speed to see how it affects the pulsing.

Connect the red/green LED. The red will light with current flowing in one direction; the green will light with current flowing in the other direction.

VOLTAGE, CURRENT & POWER

EMF (Electro Motive Force): Voltage: The pressure on the flow. The potential difference between the two ends of the wire. Measured in "volts".

If it was water flowing, the volts would be the pressure of the water in the pipe.

Current: How much is flowing. Measured in "amps".

If it was water flowing, the amps would be the amount of water (gallons per minute).

Power: Volts times amps. Potential times amount of flow. Measured in "watts".

If it was water, it would be the pressure times the flow rate.

For really great explorations of these ideas head to Bill Beatty's excellent electricity site. It rocks!

www.amasci.com/ele-edu.html

FURTHER READING

- *Direct Current*
- *Alternating Current*
- *RMS (Root Mean Square)*
- *Thomas Edison*
- *Nikola Tesla*
- *Michael Faraday*
- *Induction*
- *Heinrich Hertz*



800 Transfer Rd. Suite 30B, St. Paul, MN 55114
www.KidWind.org ♦ Phone: 877.917.0079
Fax: 208.485.9419

© Copyright 2013 All rights reserved