

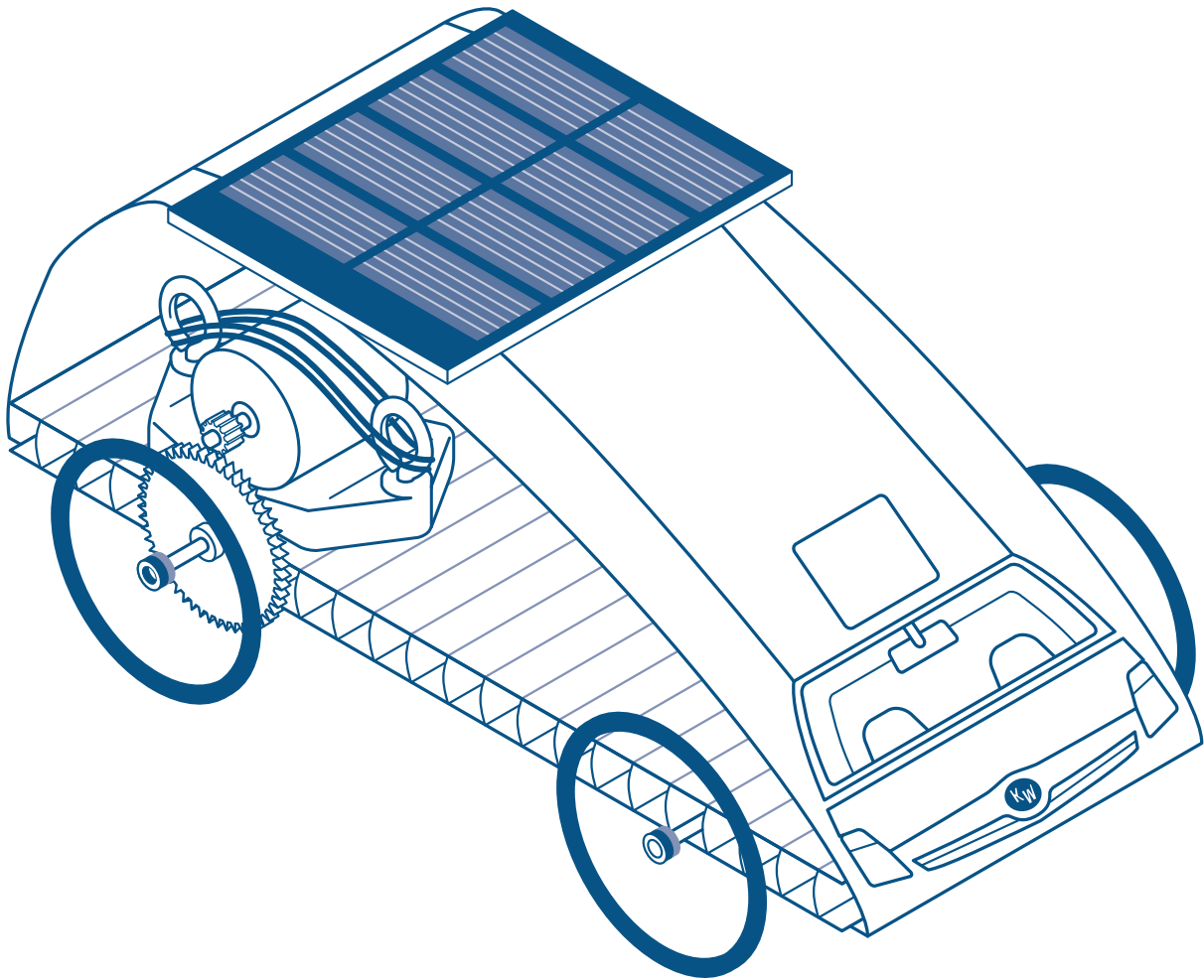

Solar Car



instructions

About KidWind

The KidWind Project is a team of teachers, students, engineers, and practitioners exploring the science behind wind energy in classrooms around the US. Our goal is to introduce as many people as possible to the elegance of renewable energy through hands-on science activities which are challenging, engaging, and teach basic science principles.

While improving science education is our main goal, we also aim to help schools become important resources for both students and the general public, to learn about and see renewable energy in action.

Thanks to ...

We would like to thank the Wright Center for Science Education at Tufts University for giving us the time and space to develop this idea into a useful project for thousands of teachers.

We would also like to thank Trudy Forsyth at the National Wind Technology Center and Richard Michaud at the Boston Office of the Department of Energy for having the vision and foresight to help establish the KidWind Project in 2004. Lastly, we would like to thank all the teachers for their keen insight and feedback on making our kits and materials first rate!

Wind for All

At KidWind, we strongly believe that K–12 education is an important foundation for promoting a more robust understanding of the opportunities and challenges that emerging clean energy technologies present.

The Wind for All program seeks to support teachers and students all over the globe who do not have the financial capacity to access our training programs and equipment. We believe that all teachers and students—regardless of where they live or what school they attend—must be part of the clean energy future.

A Note on Reproduction

This work may not be reproduced by mechanical or electronic means without written permission from KidWind, except for educational uses by teachers in a classroom situation or a teacher training workshop. For permission to copy portions or all of this material for other purposes, such as for inclusion in other documents, please contact Michael Arquin at KidWind: michael@KidWind.org



Our plastic components are made from recycled resins.



Made in US

We source domestically whenever possible, and assemble and pack our kits in St. Paul, MN.



Proceeds from your purchase help us train and supply teachers.

Parts

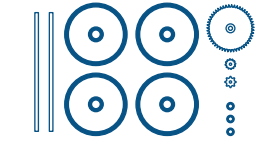

1

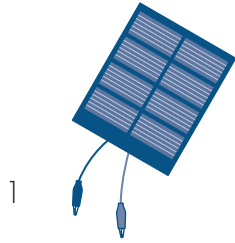

1



1



1



2

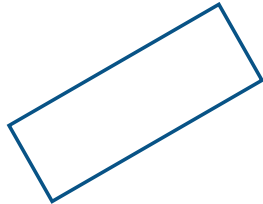

1



2



2

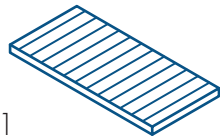

1

Solar Car

Parts List

- 1 Drivetrain assembly pack
- 1 Solar panel 2.0V/200mA
- 1 Motor
- 1 ALTurbine motor mount
- 2 Rubber bands
- 1 Cardstock car topper
- 2 Eyelet bolt
- 2 Nut
- 1 Corrugated plastic chassis

How to Build the Solar Car

Building the Car Chassis

1. Place the blue plastic motor mount over the two pre-drilled holes. Insert two eyelet bolts through the holes in the motor mount and chassis and secure with nuts. Use your hand to tighten. Over tightening can damage the chassis and make the car inoperable.

2. Push one of the small pinion gears onto the shaft of the motor.

3. To secure the motor to the mount, hook two rubber bands around the eyelets.

4a. Now let's put the rear wheels together. Rest the large gear with the flat side up on a hard, flat work surface. Line the axle up with the hole in the gear and, using a rubber mallet or hammer, tap the axle into the gear.

4b. Once the end of the axle is protruding slightly from the gear, you can push the gear further onto the axle with your thumbs. Position your thumbs close to the center of the gear. Be sure NOT to grab the gear from the outside and push, as this can snap the gear. Stop pushing when the axle protrudes from the gear about 1 cm.

5. Tap the axle and gear into one of the wheels using a rubber mallet or a hammer.

6. Slide the axle through the corrugation of the chassis so the big gear on the axle aligns with the small gear on the motor. This may take some trial and error.

7. To complete rear wheel assembly, slide one of the black rubber O-rings onto the other end of the axle. The O-rings will keep your wheel assembly centered. Tap the wheel on using a rubber mallet or hammer.

8a. To assemble the front wheels, slide an O-ring onto one end of the other axle. Place a wheel on your work surface and tap the axle into it.

8b. Slide the axle through one of the corrugations near the front of the car. Press on the remaining O-ring, followed by the remaining wheel. Tap into place.

9. Connect the solar panel wires to the motor. Place the car in full sun and point the solar panel at the sun. Set the car on a flat, smooth surface, place the panel on the chassis and make sure it runs. If the gears bind up and the car will not move, move the rear axle to provide the proper gear mesh distance, or place thin shims under the motor.

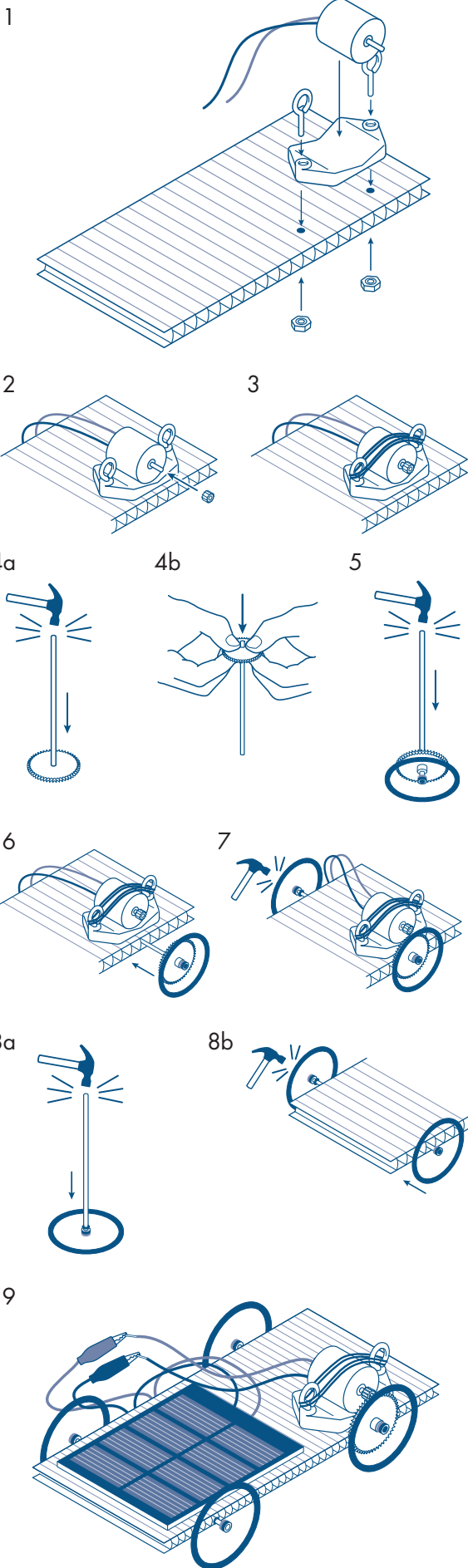

Assembling the Body

1. Fold the cardstock car body in half lengthwise where indicated (Fig 1).
2. Holding on to the ends of the cardstock, smooth the body back and forth over the edge of a table, graphic-side up (Fig 2). This will give the car "roof" a curved shape when you attach it to the chassis and prevent bubbles from appearing in the cardstock.
3. Fold sharply along the dashed fold lines at either end of the body. Lightly crease the remaining dashed line (Fig 3).
4. Attach the pieces of Velcro to the body where indicated by the dashed squares, then attach Velcro to the back of the solar panel (Fig 4).
5. Wrap the folded ends of the cardstock over the ends of the chassis and tape in place (Fig 5).
6. In a sunless area, attach the solar panel and the motor in one of two ways:
 - Use the alligator clips from the solar panel to clip to the ends of the motor wires
 - Loosen the screws on the back of the solar panel. Remove the clip cords. Insert the ends of the motor wires directly into the terminals and tighten the screws. You may want to cut and re-strip the motor wires to make them shorter.
7. Attach the solar panel to any of the Velcro squares on the car body. The angle of the solar panel can be changed on the fly to adjust for the sun's position.
6. Test the car in full sun; if it moves backwards, reverse the wires on the panel.
7. Congratulations, your Solar Car is ready to go!

Fig. 1

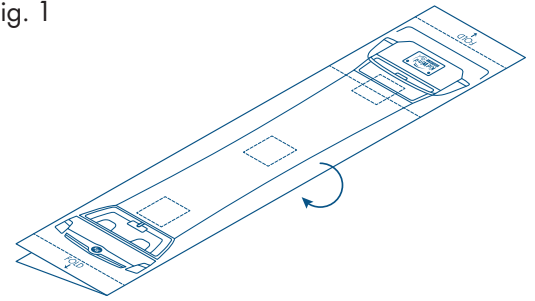

Fig. 2

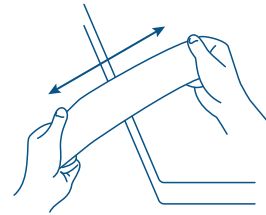

Fig. 3



Fig. 4

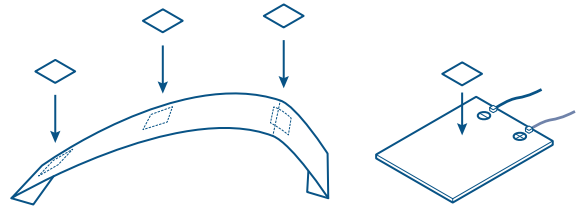
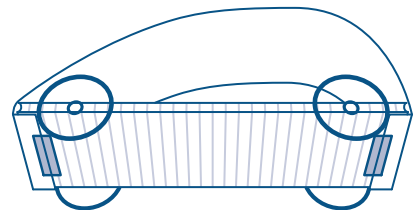
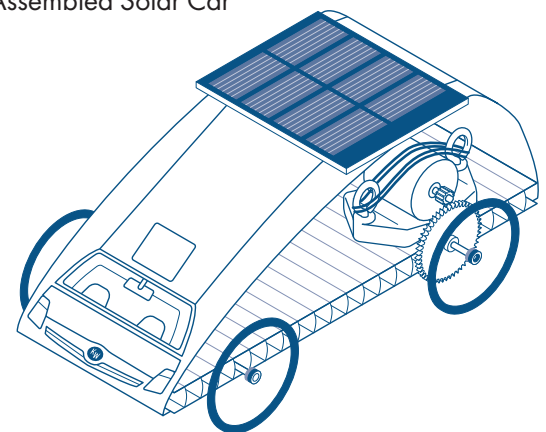

Fig. 5



Assembled Solar Car



Experiment Ideas

1. You can attach the solar panel to any of the three locations on the roof. Compare the difference in car speed from each of the solar panel locations by marking a 10 foot length area, and timing the car with the solar panel in each location on the car cover. What are your results? Why?
2. Is there a time of day when your Solar Car goes the fastest?
3. Are there clouds in the sky? Does this make a difference?
4. Can you increase the car speed by concentrating the sunlight? Try reflecting light onto the solar panel. Is there a change?
5. Try removing the pinion gear on the driveshaft and replace with the second pinion gear. Run the same trails as above and compare your results. You may have to adjust the clearance between the new gears by changing the "channel" that the rear axle goes through; or changing the shim under the motor. Which gear is faster? Why?
6. The large gear has 64 teeth. How many does each of the pinion gears have?
7. What is the gear ratio of each gearing setup?
8. What advantages and disadvantages are there for each pinion gear?
9. Can you think of a way to store some electricity so your car could drive through a tunnel or through some shade? What other materials would you need to do this?

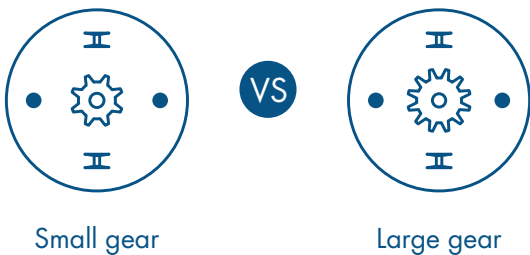
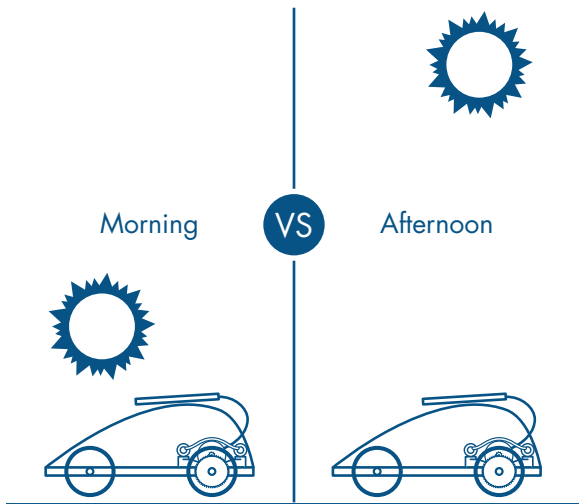
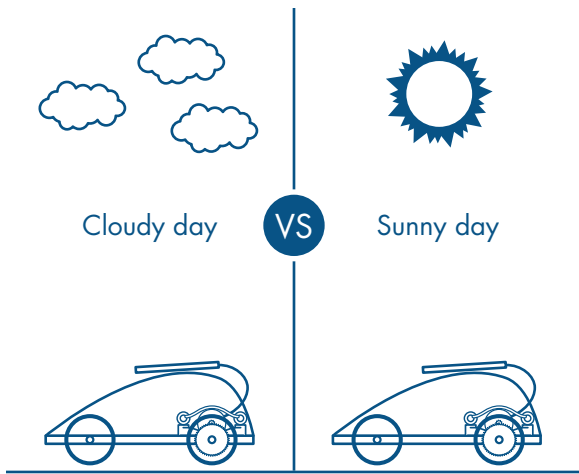

What is Solar energy? How does it work?

Every day, the sun sends out an enormous amount of energy. It radiates more energy in one second than the world has used since time began! This radiant energy, also known as solar energy, is vital to us because it provides the world directly—or indirectly—with almost all of its energy. In addition to providing the energy that sustains the world, solar energy is stored in fossil fuels and biomass, and is responsible for powering the water cycle and producing wind!

Solar energy comes from within the sun itself. Like other stars, the sun is a big ball of gases, mostly hydrogen and helium. The hydrogen atoms in the sun's core combine to form helium and radiant energy in a process called *nuclear fusion*. This process creates a large amount of radiant energy, which is emitted into space. Only a small portion of the energy radiated by the sun into space strikes the earth, one part in two billion. Yet this amount of energy is enormous. Every day, enough energy strikes the United States to supply the nation's energy needs for one and a half years!

Solar energy is considered a renewable energy source. Renewable sources of energy are resources that are continually renewed by nature, and hence will never run out. Solar power is considered renewable because the nuclear (fusion) reactions that power the sun are expected to keep generating sunlight for many billions of years to come.

Solar Electricity and Photovoltaic Systems

Solar energy can also be used to make electricity. This is done largely through the use of photovoltaic (or PV) systems. Photovoltaic comes from the words photo, meaning light, and volt, a measurement of electricity. Photovoltaic cells are often called solar cells. They convert light directly into electricity.

The photovoltaic effect is the basic physical process through which a PV cell converts sunlight directly into electricity. PV technology works any time the sun is shining, but more electricity is produced when the light is more intense and when it is striking the PV modules directly when the rays of sunlight are perpendicular to the PV modules.

Sunlight is composed of photons, or bundles of radiant energy. When photons strike a PV cell, they may be reflected or absorbed, or transmitted through the cell. Only the absorbed photons generate electricity. When the photons are absorbed, the energy of the photons is transferred to electrons in the atoms of the solar cell.

With their newfound energy, the electrons are able to escape from their normal positions associated with their atoms to become part of the current in an electrical circuit. By leaving their positions, the electrons cause holes to form in the atomic structure of the cell into which other electrons can move.

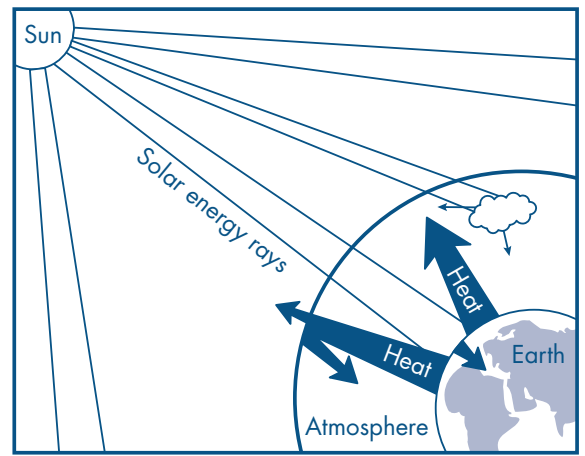

The Greenhouse Effect

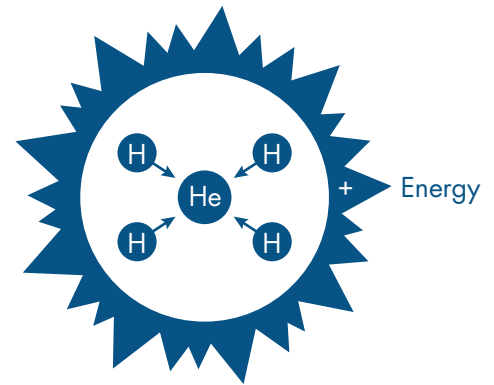

Nuclear Fusion

PHOTOVOLTAIC CELL CROSS SECTION

- ⊕ = proton ⊖ = tightly-held electron
- = free electron ○ = can accept an electron

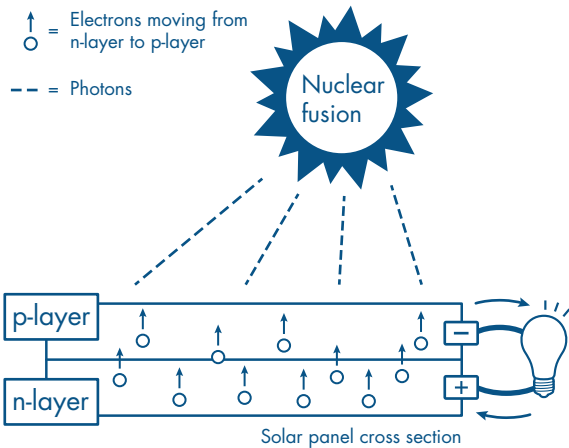
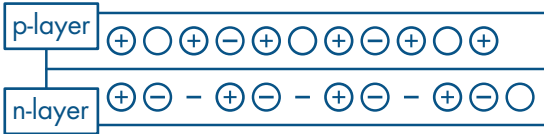

Excited electrons flow through the silicon semiconductor from the N-Layer to the P-Layer. They flow out the negative terminal, through the circuit, and back to the positive terminal. When a load is attached, the electrons are forced to do work (i.e. light a bulb).



Solar panel

Solar cells are usually made of two thin pieces of silicon, the substance that makes up sand and the second most common substance on earth. Silicon is used because it is a semiconductor, or a solid that is in between a conductor and an insulator of electricity. One piece of silicon has a small amount of boron added to it, which gives it a tendency to attract electrons. It is called the P-Layer because of its positive tendency. The other piece of silicon has a small amount of phosphorous added to it, giving it an excess of free electrons. This is called the N-Layer because it has a tendency to give up negatively charged electrons. When the two pieces of silicon are placed together, some electrons from the N-Layer flow to the P-Layer and an electric field forms between the layers. The P-Layer now has a negative charge and the N-Layer has a positive charge.

When the PV cell is placed in the sun, the radiant energy energizes the free electrons. If a circuit is made connecting the layers, electrons flow from the N-Layer through the wire to the P-Layer. The PV cell is producing electricity—the flow of electrons. If a load such as a light bulb is placed along the wire, the electricity will do work as it flows.

Compared to other ways of producing electricity, PV systems are expensive. This is mainly because PV cells require silicon that is extremely pure. This level of purity makes the silicon expensive. However, despite the high cost, PV systems have many useful applications and their demand is growing rapidly.

Resources

For more information, check out these great resources on solar energy!

The NEED Project (www.Need.org)

<http://www.need.org/needpdf/Photovoltaics%20Student%20Guide.pdf>

<http://www.need.org/needpdf/ExploringSolarStudent.pdf>

The United States DOE Office of Energy Efficiency and Renewable Energy

<http://www1.eere.energy.gov/kids/roofus/>

http://www.eere.energy.gov/basics/renewable_energy/photovoltaics.html

Other cool sites

www.solarschoolhouse.org/

<http://www.solar4rschools.org/>

americansolarchallenge.org/

www.worldsolarchallenge.org/

<http://www.energyquest.ca.gov/story/chapter15.html>

<http://science.howstuffworks.com/environmental/energy/solar-cell.htm>

<http://www.schoolgen.co.nz/se/>

<http://solardat.uoregon.edu/SunChartProgram.html>

Solar Boats

<http://original.solar-active.com/boat.htm>

<http://www.members.iinet.net.au/~gveale/solar/>



800 Transfer Road, Suite 30B, St. Paul, MN 55114
www.kidwind.org ♦ Phone: 877.917.0079
Fax: 208.485.9419

© Copyright 2013 All rights reserved