

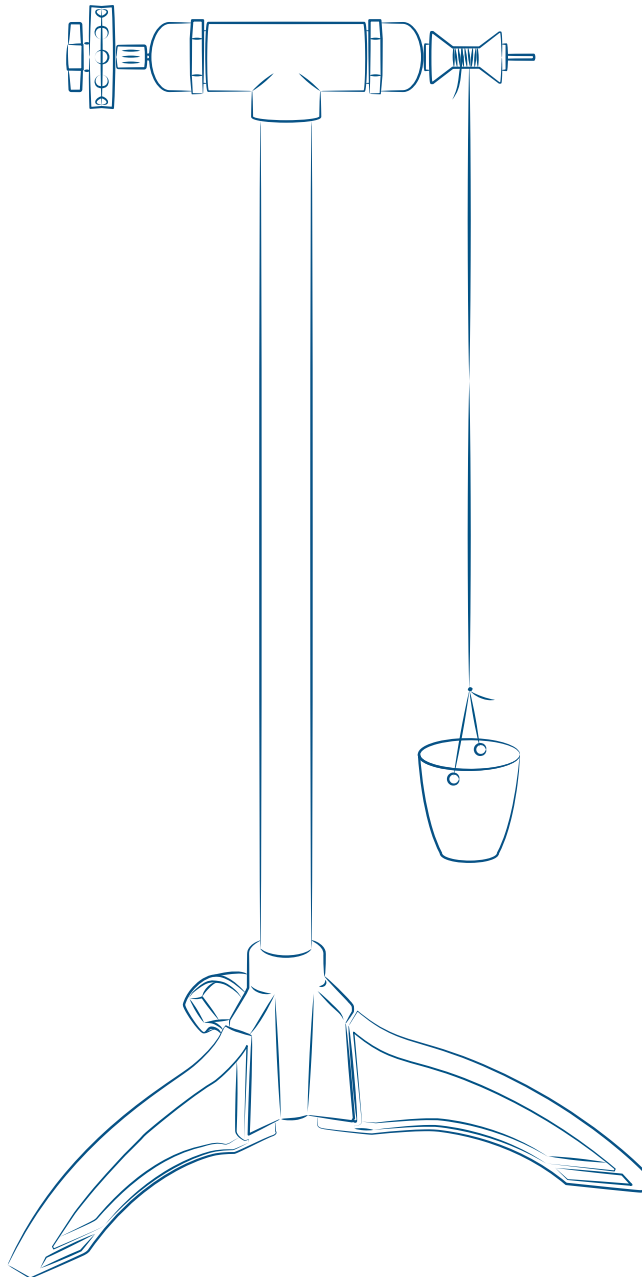

Weightlifter Nacelle Only



instructions

About KidWind

The KidWind Project is a team of teachers, students, engineers, and practitioners exploring the science behind wind energy in classrooms around the US. Our goal is to introduce as many people as possible to the elegance of renewable energy through hands-on science activities which are challenging, engaging, and teach basic science principles.

While improving science education is our main goal, we also aim to help schools become important resources for both students and the general public, to learn about and see renewable energy in action.

Thanks to . . .

We would like to thank the Wright Center for Science Education at Tufts University for giving us the time and space to develop this idea into a useful project for thousands of teachers.

We would also like to thank Trudy Forsyth at the National Wind Technology Center and Richard Michaud at the Boston Office of the Department of Energy for having the vision and foresight to help establish the KidWind Project in 2004. Lastly, we would like to thank all the teachers for their keen insight and feedback on making our kits and materials first rate!

Wind for All

At KidWind, we strongly believe that K–12 education is an important foundation for promoting a more robust understanding of the opportunities and challenges that emerging clean energy technologies present.

The Wind for All program seeks to support teachers and students all over the globe who do not have the financial capacity to access our training programs and equipment. We believe that all teachers and students—regardless of where they live or what school they attend—must be part of the clean energy future.

A Note on Reproduction

This work may not be reproduced by mechanical or electronic means without written permission from KidWind, except for educational uses by teachers in a classroom situation or a teacher training workshop. For permission to copy portions or all of this material for other purposes, such as for inclusion in other documents, please contact Michael Arquin at KidWind: michael@KidWind.org



Our plastic components are made from recycled resins.



Made in US

We source domestically whenever possible, and assemble and pack our kits in St. Paul, MN.



Proceeds from your purchase help us train and supply teachers.

Parts



1



25



2



1



2

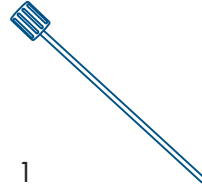

1

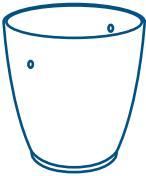

1



1



2



1



25

Weightlifter Nacelle Only Parts List

1 Wind turbine hub

25 Dowels, 1/4 inch

2 HDPE, 2 inch lengths

1 Tee Fitting

1 Slip Cap

1 Hex Driveshaft with Hub Quick Connect

1 Small Plastic Bucket

1 String

2 Hex Lock

1 Spool

25 Weights

The Weightlifter Turbine is designed to explore how well a wind turbine can move heavy objects. Before there were electrical generating wind turbines, windmills were used to grind grain, pump water and saw wood—today many windmills are still used to do these jobs. The wind machines often required the designers to create blades and drive trains that could move large stones, gears, or heavy water. These instructions will show how to build the Weightlifter and conduct a few simple experiments.

DIY PVC tower

Parts needed

All PVC is 1" diameter, schedule 40.

4 90° PVC fittings

6 6" PVC pipe sections

2 PVC T-fittings; drill a small hole in one "T"

1 24" PVC pipe section

Instructions

1. Insert one 6" piece of PVC into each of the 90° PVC fittings.
2. Use each of the PVC T's as a connector for two of the pieces you constructed in step one. When assembled, the pieces should form a straight line. The open ends of the T's should be positioned parallel to the ground and facing each other.
3. To construct the leg connector portion, insert the two remaining sections of 6" PVC into the remaining PVC T-fitting so that the open end of the T is pointing upwards and the pipes form a straight line.
4. To finish constructing the base of your tower, insert the open pipe ends of the leg connector portion into the open ends of the PVC T-fittings in the leg halves.
5. Insert the 24" PVC pipe into the open and upwards-facing portion of the leg connector's PVC T. Straighten all parts and make sure joints are secure.
6. Finally, attach your Weightlifter Nacelle on top of the 24" tower.

Fit the parts together without using glue. (PVC glue is really nasty stuff.) To make them fit snugly, tap them together with a hammer or bang them on the floor once they are assembled.

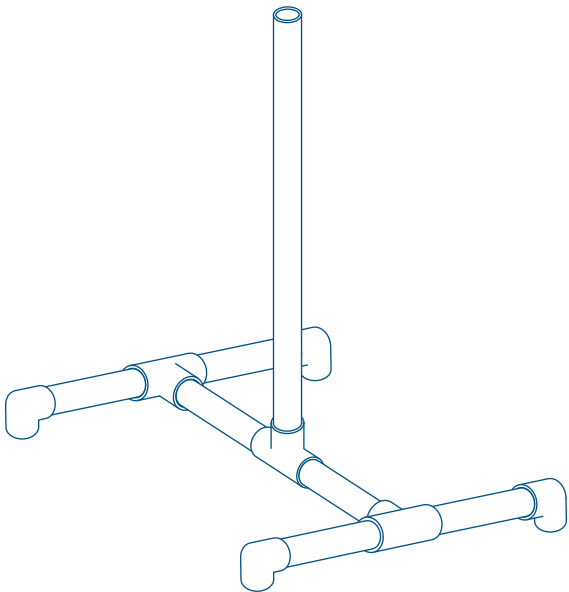
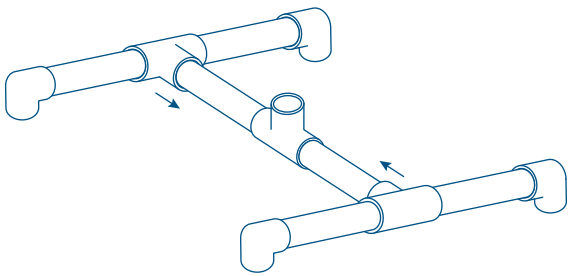
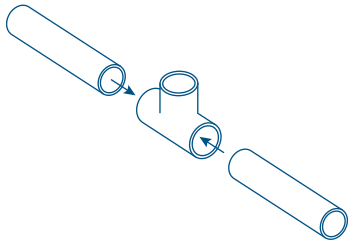
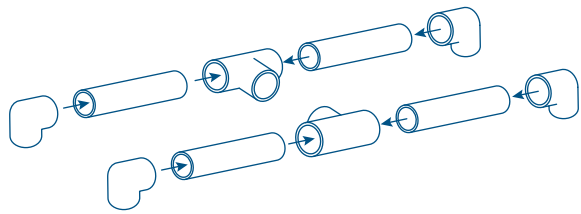

NO NEED TO GLUE

It is not necessary to glue the joints. PVC glue is nasty stuff. Omitting glue out also lets you take the tower apart for storage.

Building the Weightlifter Nacelle (Head)

1. Insert one 2" section of HDPE pipe into each drilled PVC slip cap.
2. Insert the other side of one 2" HDPE pipe into one side of a PVC Tee fitting.
3. Push the steel hex driveshaft through the drilled hole on the PVC slip cap. The green Hub Quick Connect will end up next to the slip cap.
4. Slide the steel drivshaft through the 2" HDPE section and out the drilled hole of the second PVC slip cap. Attach the KidWind Crimping Hub to the Hub Quick Connect.
5. Push one of the hex locks onto the back of the steel driveshaft. This hex lock can push down until it is almost touching the PVC slip cap. Make sure the flange is facing backwards, as the spool will lock onto this flange.
6. Insert one of the wooden spools behind this pulley. The diameter of your spool will affect the mechanical advantage of your windmill.
7. Push the second green hex lock behind the wooden spool to secure it in place. This time the flange should face forward to lock into the spool.
8. Tie, tape or glue the string to the wooden spool so that it will wind up when the hub rotates.
9. Attach the other end of the string to the plastic cup. Your weightlifter nacelle is now complete. Time to build some blades!

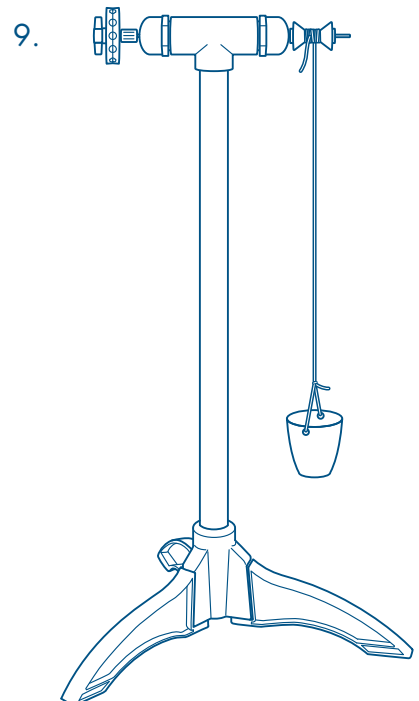
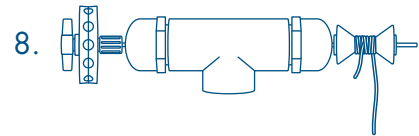
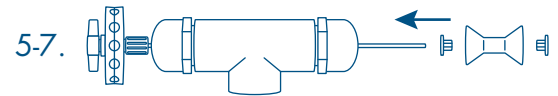
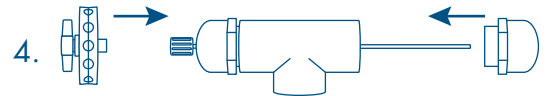
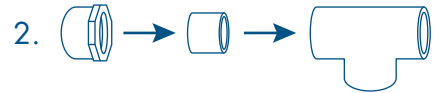

What can you do with your turbine?

Factors that Affect Power Output

How much power is your wind turbine producing? The weightlifter turbine uses simple machines (pulleys, wheels) to transform the energy in the wind to lift heavy objects. There are two factors that determine how much power your turbine is producing: the amount of weight it can lift, and how fast the weight is lifted. Look at the next page to learn more about power in the wind and how to get the most out of your turbine. Once you have read through the materials, start experimenting! What factors can you change to increase the output of your turbine?

Here are a few ideas for starters:

- Wind speed
- Blades
- Diameter of driveshaft, adding gears, etc.

Blade Design

An entertaining group of experiments involves blade design. The blades on modern turbines “capture” the wind and use it to rotate the shaft of a generator. The spinning shaft of the generator spins magnets near wires and generates electricity. The Weightlifter Turbine does not produce electricity, but works in much the same way to convert wind into power. How well you design and orient your blades can greatly impact how much power your turbine produces.

The ideal blade setup for the Weightlifter Turbine may be different than the ideal blade setup for an electricity producing turbine. When producing electricity, the goal is to make the rotor spin as fast as possible to spin the generator faster. When lifting weights, however, your blades need to provide lots of torque (muscle), not just speed. It can really pay off to experiment with your blades until you find a setup that provides lots of torque and speed.

Experiments with blades can be simple or very complicated, depending on how deeply you want to explore. Some variables you can test with blades include:

- Length
- Materials
- Shape
- Pitch
- Number
- Weight

If you are doing this for a science fair or project you should focus on just one of these variables at a time, as your results can get confusing quite quickly!

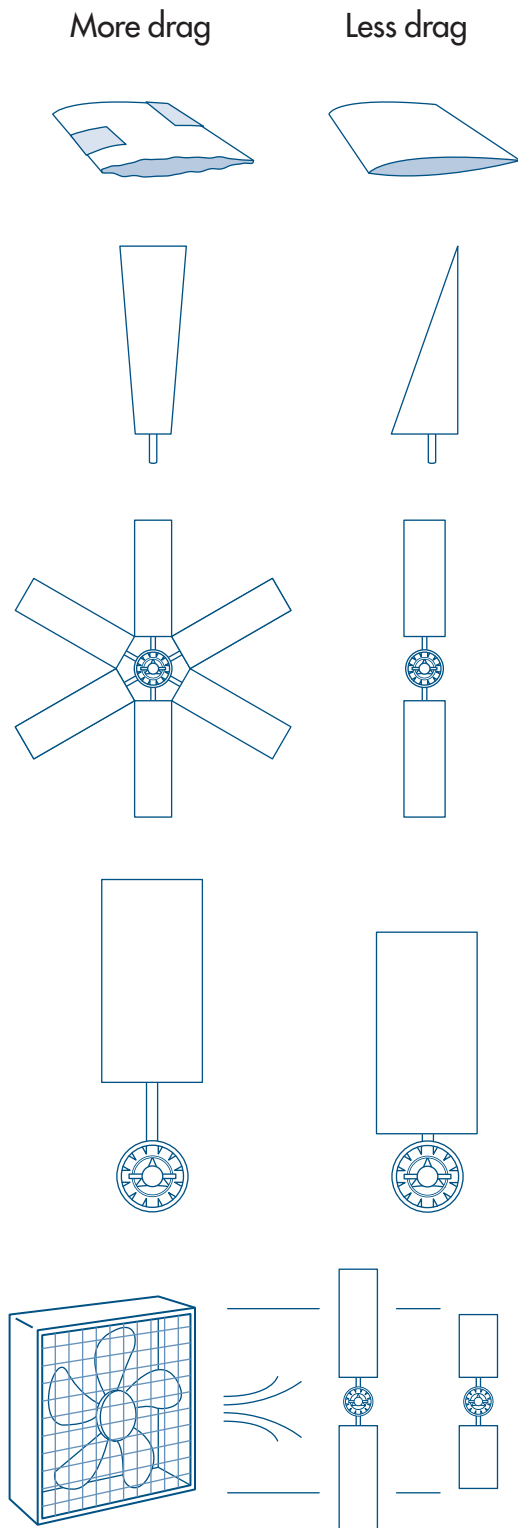

Experiment Ideas

How many weights can your model lift?

Using your preliminary blade setup and design, how many weights does your turbine lift? Can you fill the bucket and still lift it? The most efficient turbine will lift a lot of weight with a low wind speed. Try moving your turbine away from the fan or leaving the fan on a low setting. How much weight can you lift now?

Experiment with the number of blades

For this experiment it is important to keep the pitch of the blades constant. How many blades did you use? What happens if you only use two blades? Next try three, six blades, even one! Is there a relationship between the number of blades and the lifting capacity of the turbine? Will six blades lift twice as much weight as three blades? Is there some point where adding blades makes the wind turbine less efficient?

When testing the number of blades, one strategy is to keep the weight constant while altering the blade number. Then measure the time it takes to lift the weight to determine which blade setup gives you the most power. The faster it lifts the weights the more power you are generating.

What blade number gives you the most power? Why?

Experiment with the blade pitch

For this experiment it is important to keep the number of blades constant.

When the blades are flat against the wind (0°), the air will push the blades in the same direction as the wind. This results in a minimum transfer of energy from the moving air. Likewise, when the blades are 90° , or perpendicular, to the wind, there is no push at all from the moving air since there is very little exposed surface. Half-way between these two extremes, at 45° , some of the force pushes the arm sideways while some force pushes it backwards. Therefore, in principle, an angle of 45° should provide for the maximum push from the wind... is this true?

Experiment with different blade angles. Again, it might be a good strategy to keep the weight a constant and only adjust your angle. Measure the time it takes to lift the weight as you change your blade pitch.

What blade pitch gives you the most power? Why?

Blade pitch

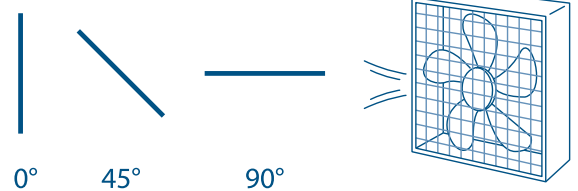



800 Transfer Road, Suite 30B, St. Paul, MN 55114
www.kidwind.org ♦ Phone: 877.917.0079
Fax: 208.485.9419

© Copyright 2013 All rights reserved